

DEPARTMENT OF THE ARMY TECHNICAL BULLETIN
CALIBRATION PROCEDURE FOR
DIGITIZING OSCILLOSCOPE,
TEKTRONIX, MODEL TDS540B

Headquarters, Department of the Army, Washington, DC
 3 December 1997

Approved for public release; distribution is unlimited

REPORTING OF ERRORS

You can help improve this publication by calling attention to errors and by recommending improvements and stating your reasons for the recommendations. Your letter or DA Form 2028, Recommended Changes to Publications, should be mailed directly to Commander, U.S. Army Aviation and Missile Command, ATTN: AMSAM-TMD-EP, Redstone Arsenal, AL 35898-5400. You may also contact this office electronically. E-mail address is tmdee@redstone.army.mil. FAX to DSN 788-2313 (commercial 205-842-2313). A reply will be furnished directly to you.

SECTION		Paragraph	Page
I.	IDENTIFICATION AND DESCRIPTION		
	Test instrument identification	1	2
	Forms, records, and reports	2	2
	Calibration description	3	2
II.	EQUIPMENT REQUIREMENTS		
	Equipment required	4	3
	Accessories required	5	4
III.	CALIBRATION PROCESS		
	Preliminary instructions	6	4
	Equipment setup	7	5
	Self tests	8	5
	Offset	9	11
	Dc voltage	10	13
	Analog bandwidth	11	14
	Channel delay	12	16
	Time base	13	19
	Pulse width triggering	14	21
	Trigger-level	15	24
	Sensitivity and edge trigger	16	26
	Trigger output signal	17	31
	Probe compensator output signal	18	34
	Final procedure	19	36
IV.	ADJUSTMENT PROCESS		
	Preliminary instructions	20	36
	Equipment setup	21	36
	Adjustment process.	22	37

SECTION I IDENTIFICATION AND DESCRIPTION

1. Test Instrument Identification. This bulletin provides instructions for the calibration of Digitizing Oscilloscope, Tektronix, Model TDS540B. The manufacturer's manual was used as the prime data source in compiling these instructions. The equipment being calibrated will be referred to as the TI (test instrument) throughout this bulletin.

a. Model Variations. None.

b. Time and Technique. The time required for this calibration is approximately 8 hours, using the dc and low frequency technique.

2. Forms, Records, and Reports

a. Forms, records, and reports required for calibration personnel at all levels are prescribed by TB 750-25.

b. Adjustments to be reported are designated (R) at the end of the sentence in which they appear. Report only those adjustments made and designated with (R).

3. Calibration Description. TI parameters and performance specifications which pertain to this calibration are listed in table 1.

Table 1. Calibration Description

Test instrument parameters	Performance specifications
DC Gain	Range: 1 mV/div to 10 V/div Accuracy: $\pm 1\%$
DC Voltage ¹	
Average of >16 waveforms	Accuracy: $\pm((1.0\% \times \text{I reading} - \text{Net Offset} \text{ I}) + \text{Offset Accuracy} + (0.6 \text{ div} \times \text{V/div}))$
Delta volts between any two averages of >16 waveforms acquired under the same setup and ambient conditions	Accuracy: $\pm((1.0\% \times \text{I reading I}) + (0.1 \text{ div} \times \text{V/div}) + 0.3 \text{ mV})$
Bandwidth ²	
DC to 500 MHz	Range: 10 mV/div to 1V/div 5 mv/div to 9.95 mV/div 2 mv/div to 4.98 mV/div DC to 500 MHz
DC to 450 MHz	Range: 1 mv/div to 1.99 mV/div

See footnotes at end of table.

Table 1. Calibration Description - Continued

Test instrument parameters	Performance specifications
Offset	Range: 1 mV/div to 100mV/div Accuracy: $\pm((0.2\% \times \text{Net Offset}^1) + 1.5 \text{ mV} + (0.1 \text{ div} \times \text{V/div}))$ Range: 101 mV/div to 1 V/div Accuracy: $\pm((0.25\% \times \text{Net Offset}^1) + 15 \text{ mV} + (0.1 \text{ div} \times \text{V/div}))$ Range: 1.01 V/div to 10 V/div Accuracy: $\pm((0.25\% \times \text{Net Offset}^1) + 150 \text{ mV} + (0.1 \text{ div} \times \text{V/div}))$
Delay	≤ 50 ps for any two channels with equal volts/div and coupling settings
Time Base	± 100 ppm over any 21 ms interval ³
Input Impedance	Range: Dc to 1 M Ω Coupled Accuracy: 1 M Ω $\pm 0.5\%$ in parallel with 10 pF ± 3 pF Range: DC to 50 M Ω Coupled Accuracy: 50 Q $\pm 1\%$ with VSWR $\leq 1.3:1$ from Dc to 500 MHz, $\leq 1.5:1$ from 500 MHz to 1 GHz
Input Voltage	Range: DC - 1 M Ω , AC - 1 M Ω , or GND Coupled Accuracy: ± 300 V (DC + peak AC), 400 V peak; derate at 20 dB/decade above 1 MHz, CAT II Range: Dc - 50 Ω or ac - 50Q coupled Accuracy: 5 VRNMS, with peaks $< +30$ V
Long Term Sample Rate and Delay Time	Accuracy: ± 25 ppm over any > 1 ms interval
Sensitivity and Edge Trigger	Any Channel: 0.35 div from dc to 50 MHz, increasing to 1 div at 500 MHz Auxiliary: 400 mV from dc to 50 MHz, increasing to 750 mV at 100 MHz
Pulse-Width Triggering	Range: 1 ns to 1 ps Accuracy: $\pm(20\%$ of setting $+ 0.5$ ns) Range: 1.02 ps to 1 s Accuracy: $\pm(100$ ns $+ 0.01\%$ of setting)
Trigger Output	
V _{OUT} (HI)	Accuracy. ≥ 2.5 open circuit; ≥ 1.0 V into a 50 Ω load to ground
V _{out} (LO)	Accuracy: ≤ 0.7 V into a load of ≤ 4 mA; ≤ 0.25 V into a 50 Ω load to ground

¹Net Offset = Offset - (Position x Volts/Div). Net Offset is the nominal voltage level at the oscilloscope input that corresponds to the center of the A-D converter dynamic range Offset Accuracy is the accuracy of this voltage level.

²The limits given are for the ambient temperature range of 0°C to +30°C Reduce the upper bandwidth frequencies by 2.5 MHz for each °C above +30°C

³Due to STANDARDS limitations, this specification does not agree with manufacturer's stated accuracies.

SECTION II EQUIPMENT REQUIREMENTS

4. Equipment Required. Table 2 identifies the specific equipment to be used in this calibration procedure. This equipment is issued with Secondary Transfer Calibration Standards Set AN/GSM-286. Alternate items may be used by the calibrating activity. The items selected must be verified to perform satisfactorily prior to use and must bear evidence of current calibration. The equipment must meet or exceed the minimum use specifications listed in table 2. The accuracies listed in table 2 provide a four-to-one ratio

between the standard and TI. Where the four-to-one ratio cannot be met, the four-to-one accuracy will be listed, and the actual accuracy of the equipment selected is shown in parenthesis.

5. Accessories Required. The accessories required for this calibration are common usage accessories issued as indicated in paragraph 4 above and are not listed in this calibration procedure.

Table 2. Minimum Specifications of Equipment Required

Common name	Minimum use specifications	Manufacturer and model (part number)
CALIBRATOR	Dc voltage: Range: 0V to 18 V Accuracy: .11%	John Fluke, Model 5700A/CT (p/o MIS-35947); w/power amplifier, John Fluke, Model 5215A/CT (5215A/CT) w/transconductance amplifier, John Fluke, Model 5220A/CT (5220A/CT); w/ac divider, John Fluke, Model 7405A-4207 (7405A-4207)
OSCILLOSCOPE CALIBRATION WORKSTATION	Frequency: Range: 100 kHz to 500 MHz (12 mV to 12 V p-p) Accuracy: $\pm 2\%$ Time markers: Range: 10 ms to 10 ns Accuracy: $\pm 0.005\%$ of reading ± 10 ps (8 ppm) Square Wave: Range: 500 mV Accuracy: -25% of reading $+1$ pV	(MIS-38938) consisting of Tektronix, Type I (F7529A1) (MIS-38938 TYPE I); Tektronix, Type II (F7529A2) (MIS-38938 Type II); calibration generator, Tektronix, Type CG 5011 calibration generator, Tektronix, Type CG 5011 (CG 5011), pulse head, Tektronix, Type 015-0611-00 (015-0611-00); leveled sine wave generator, Tektronix, Type SG5030 (SG5030); w/leveling head, Tektronix, Type 015-2350-01 (015-2350-01)
MULTIMETER	Range: 1.0 to 10.0 V Accuracy: Nominal	John Fluke, Model 8840A/AF-05/09 (AN/GSM-64D)

SECTION III CALIBRATION PROCESS

6. Preliminary Instructions

a. The instructions outlined in paragraphs **6** and **7** are preparatory to the calibration process. Personnel should become familiar with the entire bulletin before beginning the calibration.

b. Items of equipment used in this procedure are referenced within the text by common name as listed in table 2.

c. Unless otherwise specified, verify the results of each test and, whenever the test requirement is not met, take corrective action before continuing with the calibration. Adjustments required to calibrate the TI are included in this procedure. Additional maintenance information is contained in the manufacturer's manual for this TI.

d. When indications specified in paragraphs **7** through **18** are not within tolerance, perform Section IV, Adjustment Process. After adjustments are made, repeat paragraphs **7** through **18**. Do not perform Section IV if all other parameters are within tolerance.

e. Unless otherwise specified, all controls and control settings refer to the TI.

f. Unless otherwise specified, all callouts referring to "main-menu" refer to the menu that labels the seven menu keys under the display, "Side-menu" refers to the menu that labels the five keys to the right of the display. "Pop-up menu" refers to a menu that pops up when a main-menu key is pressed. "Front-panel" keys refer to keys located on front panel of TI.

7. Equipment Setup

WARNING

HIGH VOLTAGE is used or exposed during the performance of the calibration. DEATH ON CONTACT may result if personnel fail to observe safety precautions. REDUCE OUTPUT(S) to minimum after each step within the performance check where applicable.

- a. Connect TI to a 115 V ac source.
- b. Press **ON/STBY** key and allow at least 20 minutes for equipment warm-up.

NOTE

When ON/STBY key is pressed, the TI automatically performs a power-on self-test sequence. Upon successful completion of self-test, TI will be in normal operating mode.

8. Self Tests

NOTE

When instructed to press a menu key, the key may already be selected (its label will be highlighted). If this is the case, it is not necessary to press the key.

- a. Internal Diagnostics

NOTE

The following performance check uses internal routines to verify the oscilloscope functions properly.

- (1) Press front-panel **SHIFT** key.
- (2) Press front-panel **UTILITY** key.
- (3) Repeatedly press main-menu **System <config>** key until **Diag/Err** is highlighted in the pop-up menu.
- (4) Disconnect any input signals from all four channels.
- (5) Press main-menu **Execute** key.

- (6) Press side-menu OK Confirm Run Test key.

NOTE

This verification will take up to three and a half minutes. A "clock" icon will appear on-screen during the verification and disappear when verification is complete.

- (7) When the verification is complete, verify that no failures are found and reported on-screen.
- (8) Press front-panel **SHIFT** key.
- (9) Press front-panel **UTILITY** key.
- (10) Repeatedly press main-menu **System <config>** key until **<Cal>** is highlighted in the pop-up menu.
- (11) Verify that the word **Pass** appears in the main-menu under the following menu labels: **Voltage Reference**, **Frequency Response**, and **Pulse Trigger**. See figure 1.

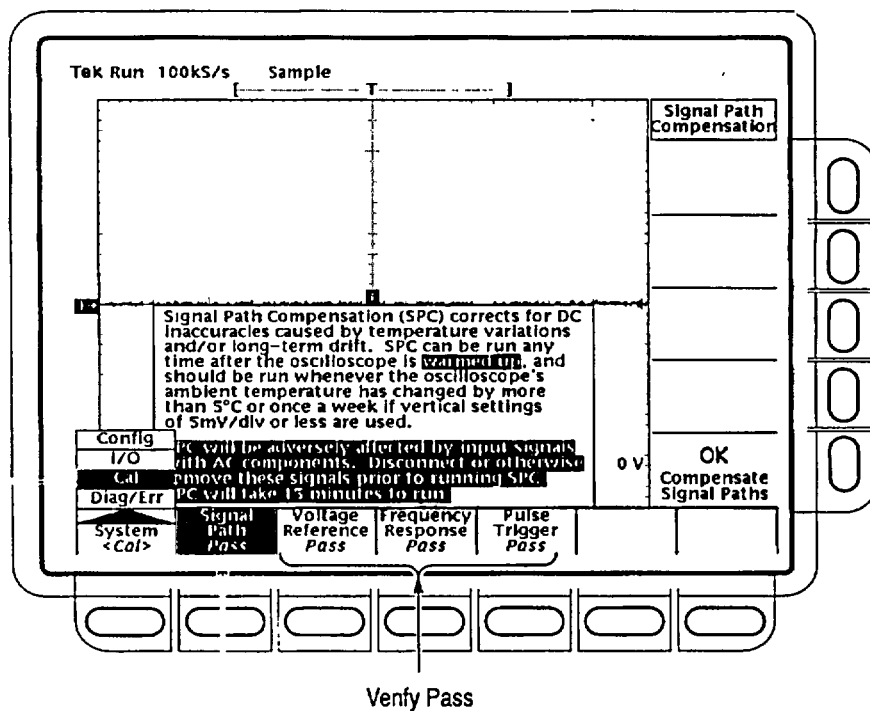

Figure 1. Pass location.

- (12) Press main-menu **Signal Path** key.
- (13) Press side-menu **OK Compensate Signal Paths** key.

NOTE

This verification will take up to five minutes. A "clock" icon will appear on-screen during the verification and disappear when verification is complete.

- (14) When the verification is complete, verify that the word **Pass** appears under **Signal Path** in the main menu.
- (15) Press front panel **CLEAR MENU** key.

NOTE

When indications specified in paragraphs b through d are not within tolerance, perform Section IV, Adjustment Process.

b. Input Channel Functional Test

- (1) Install probe **on CH 1**.

(2) Connect probe tip to front-panel **PROBE COMPENSATION SIGNAL**; connect probe ground to front-panel **PROBE COMPENSATION GND**.

- (3) Press front-panel **SETUP** key.
- (4) Press main-menu **Recall Factory Setup** key.
- (5) Press side-menu **OK Confirm Factory Init** key.

NOTE

This verification will take up to 15 seconds. A "clock" icon will appear on-screen during the verification and disappear when verification is complete.

- (6) Press front-panel **WAVEFORM OFF** key.
- (7) Press front-panel **CH 1** key.
- (8) Press front-panel **TRIGGER MENU** key.
- (9) Press main-menu **Source** key.
- (10) Press side-menu **CH 1** key.
- (11) Adjust front-panel **VERTICAL SCALE** knob for an on-screen display of **200 mV**.

- (11) Adjust front-panel **VERTICAL SCALE** knob for an on-screen display of **200 mV**.
- (12) Adjust front-panel **HORIZONTAL SCALE** knob for an on-screen display of **200 ms**.
- (13) Press front-panel **CLEAR MENU** key.
- (14) Verify the vertical scale readout displays a setting of 200 mV, and a squarewave probe-compensation signal about 2.5 divisions in amplitude.
- (15) Rotate front-panel **VERTICAL POSITION** knob to verify the signal moves up and down the screen when rotated.
- (16) Rotate front-panel **VERTICAL SCALE** knob counterclockwise to verify a decrease in waveform amplitude.
- (17) Rotate front-panel **VERTICAL SCALE** knob clockwise to verify a increase in waveform amplitude.
- (18) Adjust front-panel **VERTICAL SCALE** knob to display **200 mV**; verify waveform amplitude of 2.5 divisions.
- (19) Press front-panel **SHIFT** key; then press **ACQUIRE MENU**.
- (20) Press side-menu **Sample** key. Verify noise present on peaks of the squarewave.
- (21) Press side-menu **Peak Detect** key. Verify peaks have been added to the squarewave.
- (22) Press side-menu **Hi Res** key. Verify reduced noise on the squarewave.
- (23) Press side-menu **Envelope** key. Verify noise and peaks on the squarewave.
- (24) Press side-menu **Average key**. Verify reduced noise on the squarewave.
- (25) Repeat technique of (1) through (24) above for **CH 2**, **CH 3**, and **CH 4**.
- (26) Disconnect probe tip from **PROBE COMPENSATION SIGNAL**; disconnect probe ground from **PROBE COMPENSATION GND**.

c. Time Base Functional Test

- (1) Install probe on **CH 1**.
- (2) Connect probe tip to **PROBE COMPENSATION SIGNAL**; connect probe ground to **PROBE COMPENSATION GND**.

- (3) Press front-panel **SETUP** key.
- (4) Press main-menu **Recall Factory Setup** key.
- (5) Press side-menu **OK Confirm Factory Init** key.
- (6) Adjust front-panel **VERTICAL SCALE** knob to display **200 mV**.
- (7) Adjust front-panel **HORIZONTAL SCALE** knob to display **200 μ s**.
- (8) Press front-panel **CLEAR MENU** key.
- (9) Verify the waveform is about five horizontal divisions.
- (10) Rotate front-panel **HORIZONTAL POSITION** knob to verify the signal moves up and down the screen when rotated.
- (11) Rotate front-panel **HORIZONTAL SCALE** knob counterclockwise to verify a contraction in the waveform.
- (12) Rotate front-panel **HORIZONTAL SCALE** knob clockwise to verify a expansion in the waveform.
- (13) Adjust front-panel **HORIZONTAL SCALE** knob to display 200 IIs; verify waveform period of five divisions.
- (14) Disconnect probe tip from **PROBE COMPENSATION SIGNAL**; disconnect probe ground from **PROBE COMPENSATION GND**.

d. Main and Delayed Trigger Functional Test

- (1) Install probe on **CH 1**.
- (2) Connect probe tip to **PROBE COMPENSATION SIGNAL**; connect probe ground to **PROBE COMPENSATION GND**.
- (3) Press front-panel **SETUP** key.
- (4) Press main-menu key **Recall Factory Setup**.
- (5) Press side-menu key **OK Confirm Factory Init**.
- (6) Adjust front-panel **VERTICAL SCALE** knob to display **200 mV** on-screen.
- (7) Adjust front-panel **HORIZONTAL SCALE** knob to display **200 μ s**.
- (8) Press front-panel **TRIGGER MENU** key.

- (9) Press main-menu **Mode & Holdoff** key.
- (10) Press side-menu **Normal** key.
- (11) Press front-panel **CLEAR MENU** key.
- (12) Verify front-panel **TRIGGER MAIN LEVEL** knob can trigger and untrigger the squarewave signal as it is rotated. Leave the signal untriggered, which is indicated by the display not updating.
- (13) Press front-panel **SET LEVEL TO 50%** key and verify the squarewave signal triggers. Leave the signal triggered.
- (14) Press front-panel **HORIZONTAL MENU** key.
- (15) Press main-menu **Time Base** key.
- (16) Press side-menu **Delayed Triggerable** key.
- (17) Press side-menu **Delayed Only** key.
- (19) Adjust front-panel **HORIZONTAL SCALE** knob to display **200** μ s.
- (20) Press front-panel **SHIFT** key.
- (21) Press front-panel **DELAYED TRIG** key.
- (22) Press main-menu **Level** key.
- (23) Press side-menu **Level** key.
- (24) Verify delayed trigger level readout changes as front-panel general purpose knob is rotated.
- (25) Verify squarewave signal triggers and untriggers as front-panel general purpose knob is rotated. Leave signal untriggered, which is indicated by the front-panel "**READY**" display not updating.
- (26) Press side-menu **Set to 50%** key and verify probe-compensation signal triggers. Leave signal triggered.
- (27) Press main-menu **Delay by Time** key.
- (28) Press front-panel **1** key.
- (29) Press front-panel **ENTER** key.

(30) Verify trigger **READY** indicator on the front-panel flashes about once every second as the waveform is updated on-screen.

(31) Disconnect probe tip from **PROBE COMPENSATION SIGNAL**; disconnect probe ground from **PROBE COMPENSATION GND**.

9. Offset

a. Performance Check

- (1) Press front-panel **SETUP** key.
- (2) Press main-menu **Recall Factory Setup** key.
- (3) Press side-menu **OK Confirm Factory Init** key.
- (4) Press front-panel **CLEAR MENU** key.
- (5) Press front-panel **SHIFT** key.
- (6) Press front-panel **ACQUIRE MENU** key.
- (7) Press main-menu **MODE** key.
- (8) Press side-menu **Hi Res** key.
- (9) Press front-panel **CURSOR** key.
- (10) Press main-menu **Function** key.
- (11) Press side-menu **H Bars** key.
- (12) Press front-panel **CLEAR MENU** key.
- (13) Press front-panel **CH 1** key.
- (14) Press front-panel **VERTICAL MENU** key.
- (15) Press main-menu **Fine Scale** key.
- (16) Use front-panel keypad to enter 1 mV vertical Fine Scale setting. Press front panel **1** key.
- (17) Press front panel **SHIFT** key.
- (18) Press front panel **m** key.
- (19) Press front panel **ENTER** key.

(21) Rotate front-panel general purpose knob to align active cursor over waveform. See figure 2. If TI @ readout does not indicate within 0 V, ± 1.6 mV, perform b below.

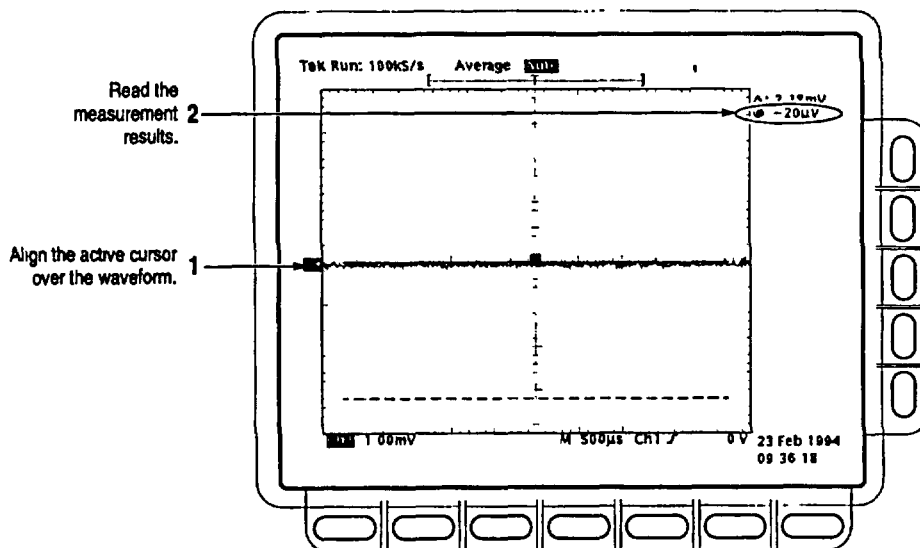

Figure 2. Dc offset.

(22) Repeat technique of (14) through (21) above for settings listed in table 3. If TI does not indicate within limits listed in table 3, perform b below.

Table 3. Offset

Test instrument vertical Fine Scale settings	Test instrument offset accuracy indications
101 mV	25.1 mV
1.01 V	251 mV

(23) Press **WAVEFORM OFF** key to remove current channel displayed.

(24) Repeat technique of (13) through (23) above for channels 2, 3, and 4. If TI does not indicate within limits listed in table 3, perform b below.

b. Adjustments. Perform Section IV below.

10. DC Voltage

a. Performance Check

- (1) Connect calibrator **OUTPUT** to **CH1**.
- (2) Press front-panel **SETUP** key.
- (3) Press main-menu **Recall Factory Setup** key.
- (4) Press side-menu **OK Confirm Factory Init** key.
- (5) Press front-panel **SHIFT** key.
- (6) Press front-panel **ACQUIRE MENU** key.
- (7) Press main-menu **Mode** key.
- (8) Press side-menu **Average 16** key.
- (9) Press front-panel **CH 1** key.
- (10) Press front-panel **MEASURE** key.
- (11) Press main-menu Select **Measrmnt** for **Ch 1** key.
- (12) Press side-menu more key until the menu label **Mean** appears in the side-menu.
- (13) Press side-menu **Mean** key.
- (14) Press front-panel **CLEAR MENU** key.
- (15) Adjust front-panel **VERTICAL SCALE** knob to display 5 mV.
- (16) Press front-panel **VERTICAL MENU** key.
- (17) Press main-menu **Position** key.
- (18) Use front-panel keypad to set vertical position to **-5** divisions. Press front-panel **-** and **5** keys.
- (19) Press front-panel **ENTER** key.
- (20) Press main-menu **Offset** key.
- (21) Use front-panel keypad to set vertical offset to 1 volt. Press front-panel **1** key.

(22) Press front-panel **ENTER** key.

(23) Position calibration generator controls for 1.040 V output. If TI **C1 Mean** readout does not indicate between 1.0355 and 1.0445 V, perform b below.

(24) Repeat technique of (16) through (23) above, reversing the polarity of the position, offset, and generator settings. If TI **C1 Mean** readout does not indicate between -1.0445 and -1.0355 V, perform **b** below.

(25) Repeat technique of (15) through (24) above for settings listed in table 4. If TI does not indicate within limits listed in table 4, perform b below.

Table 4. DC Voltage

Test instrument VERTICAL SCALE settings	Test instrument Position settings (div)	Test instrument Offset settings (V)	Calibration generator output settings	Test instrument C1 Mean indications	
				Min	Max
200 mV	-5	+10	+11.6 V	+11.5195 V	+11.6805 V
	+5	-10	-11.6 V	-11.6805 V	-11.5195 V
1 V	-5	+10	+18 V	+17.7575 V	+18.2425 V
	+5	-10	-18 V	-18.2425 V	-17.7575 V

(26) Press **WAVEFORM OFF** key to remove current channel displayed.

(27) Repeat technique of (9) through (25) above for channels 2, 3, and 4. If TI does not indicate within limits listed in table 4, perform b below.

b. Adjustments. Perform Section IV below.

11. Analog Bandwidth

a. Performance Check

- (1) Connect leveled sine wave generator leveling head to **CH 1**.
- (2) Press front-panel **SETUP** key.
- (3) Press main-menu **Recall Factory Setup** key.
- (4) Press side-menu **OK Confirm Factory Init** key.
- (5) Press front-panel **TRIGGER MENU** key.
- (6) Press main-menu **Coupling** key.
- (7) Press side-menu **Noise Rej** key.

- (8) Adjust front-panel **HORIZONTAL SCALE** knob to display **50 ns**.
- (9) Press front-panel **SHIFT** key.
- (10) Press front-panel **ACQUIRE MENU** key.
- (11) Press main-menu **Mode** key.
- (12) Press side-menu **Average 16** key.
- (13) Press front-panel **MEASURE** key.
- (14) Press main-menu **High-Low Setup** key.
- (15) Press side-menu **Min-Max** key.
- (16) Position leveled sine wave generator controls for a 6 MHz output.
- (17) Press front-panel **TRIGGER MENU** key.
- (18) Press main-menu **Source** key.
- (19) Press side-menu **CH 1** key.
- (20) Press front-panel **VERTICAL MENU** key.
- (21) Press main-menu **Coupling** key.
- (22) Press side-menu **W** key to select **50 W** setting.
- (23) Adjust front-panel **VERTICAL SCALE** knob to display **100 mV**.
- (24) Press front-panel **MEASURE** key.
- (25) Press main-menu **Select Measrmnt for CH 1** key.
- (26) Press side-menu **more** key until the menu label **Frequency** appears in the side-menu.
- (27) Press side-menu **Frequency** key.
- (28) Press side-menu **more** key until the menu label **Pk-Pk** appears in the side-menu.
- (29) Press side-menu **Pk-Pk** key.
- (30) Press front-panel **CLEAR MENU** key.

(31) Position leveled sine wave generator amplitude controls for a **Ch1 Pk-Pk** readout of **600mV** (6 divisions).

(32) Press front-panel **SET LEVEL TO 50%** key as necessary to trigger a stable display. At full bandwidth, adjust **TRIGGER LEVEL** knob to stabilize trigger.

(33) Position leveled sine wave generator controls for a 500 MHz output.

(34) Adjust front-panel **HORIZONTAL SCALE** knob to display **1 ns**. Press front-panel **SET LEVEL TO 50%** key as necessary to trigger a stable display.

(35) If TI **CH1 Pk-Pk** readout does not indicate ≥ 424 mV, perform b below.

b. Adjustments. Perform Section IV below.

12. Channel Delay

a. Performance Check

NOTE

Do not adjust the vertical position of any channel during this procedure check.

(1) Press front-panel **SETUP** key.

(2) Press main-menu **Recall Factory Setup** key.

(3) Press side-menu **OK Confirm Factory Init** key.

(4) Adjust front-panel **HORIZONTAL SCALE** knob to display **500 ps**.

(5) Press front-panel **SHIFT** key.

(6) Press front-panel **ACQUIRE MENU** key.

(7) Press main-menu **Mode** key.

(8) Press side-menu **Average 16** key.

(9) Connect leveled sine wave generator leveling head to **CH 1** and **CH 2** using 50 Ω attenuator and dual input coupler. See figure 3.

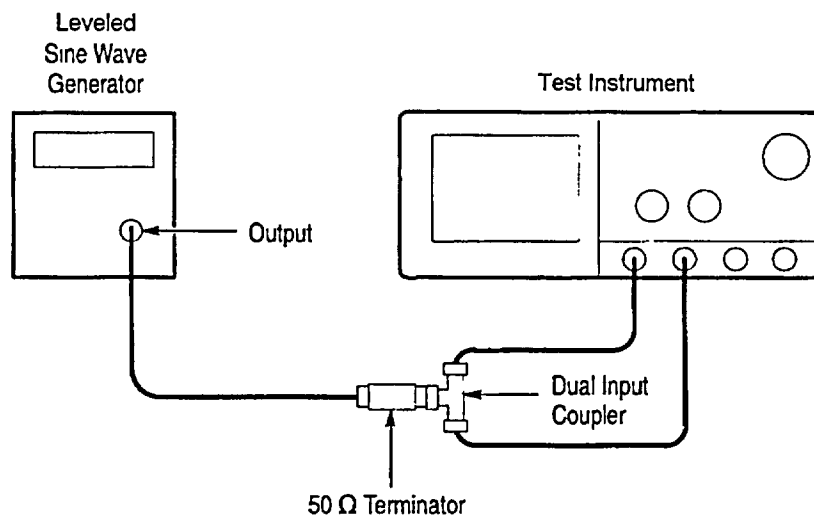

Figure 3. Equipment setup.

NOTE

As you are positioning the leveled sine wave generator amplitude, press SET LEVEL TO 50% frequently to speed up the updating of the waveform amplitude.

CH 1.

- (10) Position leveled sine wave generator controls for a 250 MHz output and amplitude for about six divisions on
- (11) Press front-panel **ZOOM** key.
- (12) Press side-menu **On** key.
- (13) Adjust front-panel **HORIZONTAL SCALE** knob to display **250 ps**.
- (14) Verify vertical scale factor is 1.0X and horizontal scale factor is 2.0X.

NOTE

If TI Vert and Horz readouts do not indicate as specified, adjust front-panel HORIZONTAL SCALE knob and VERTICAL SCALE knob.

- (15) Press **CH 2** key.
- (16) Verify vertical scale factor is 1.0X.

NOTE

If TI Vert readout does not indicate as specified, adjust front-panel VERTICAL SCALE knob.

- (17) Press front-panel **WAVEFORM** key.
- (18) Press main-menu **Save Wfm** key.
- (19) Press side-menu **To Ref 2** key.
- (20) Move dual input coupler from **CH 2** to **CH 3** key.
- (21) Press front-panel **WAVEFORM OFF** key.
- (22) Press **CH 3** key.
- (23) Verify vertical scale factor is 1.0X.

NOTE

If TI Vert readout does not indicate as specified, adjust front-panel VERTICAL SCALE knob.

- (24) Press side-menu **To Ref 3** key.
- (25) Press front-panel **WAVEFORM OFF** key.
- (26) Move dual input coupler from **CH 3** to **CH 4**.
- (27) Press **CH 4** key.
- (28) Verify vertical scale factor is 1.0X.
- (29) Press front-panel **MORE** key.
- (30) Press main-menu **Ref 2** and **Ref 3** keys.

(31) Locate time reference points for waveforms. Do this by identifying the point where the rising edge of the left-most waveform crosses the center horizontal graticule line. Next, note the corresponding time reference point for the right-most waveform. See figure 4.

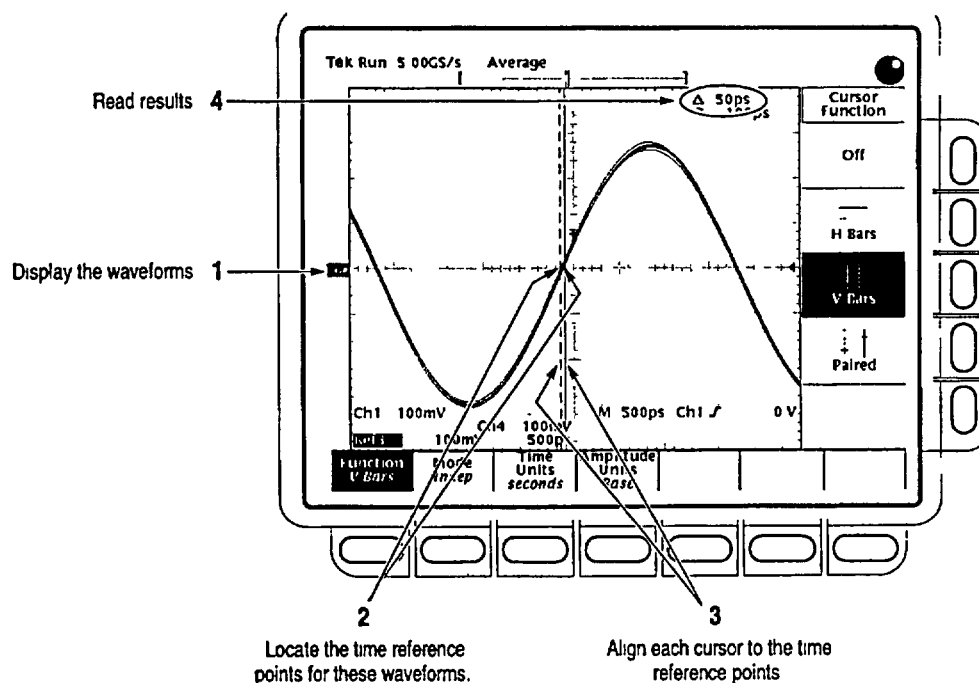

Figure 4. Channel delay.

- (32) Press front-panel **CURSOR** key.
- (33) Press main-menu **Function** key.
- (34) Press side-menu **V Bars** key.
- (35) Press front-panel **CLEAR MENU** key.

(36) Align one V bar cursor to the time reference point of the left-most waveform edge and the other cursor to the time reference point of the right-most waveform edge by rotating front-panel general purpose knob. (Press **SELECT** key to switch between the two cursors.)

- (37) If TI Δ cursor readout does not indicate ≤ 50 ps, perform **b** below.

b. Adjustments. Perform Section IV below.

13. Time Base Accuracy

a. Performance Check

- (1) Connect calibration generator trigger output to **CH 1**.
- (2) Position calibration generator output for a 10 ms marker output.
- (3) Press front-panel **SETUP** key.

- (4) Press main-menu **Recall Factory Setup** key.
- (5) Press side-menu **OK Confirm Factory Init** key.
- (6) Adjust front-panel **VERTICAL SCALE** knob to display **200 mV**.
- (7) Press front-panel **VERTICAL MENU** key.
- (8) Press main-menu **Coupling** key.
- (9) Press side-menu **W** key to select **50 W** setting.
- (10) Press front-panel **SET LEVEL TO 50%** key.
- (11) Adjust front-panel **VERTICAL POSITION** knob to center test signal.
- (12) Adjust front-panel **HORIZONTAL SCALE** knob to display 1 ms.
- (13) Press front-panel **TRIGGER MENU** key.
- (14) Press main-menu **Mode & Holdoff** key.
- (15) Press side-menu **Normal** key.
- (16) Align trigger T to center vertical graticule line by adjusting the **HORIZONTAL POSITION** knob. See figure

5.

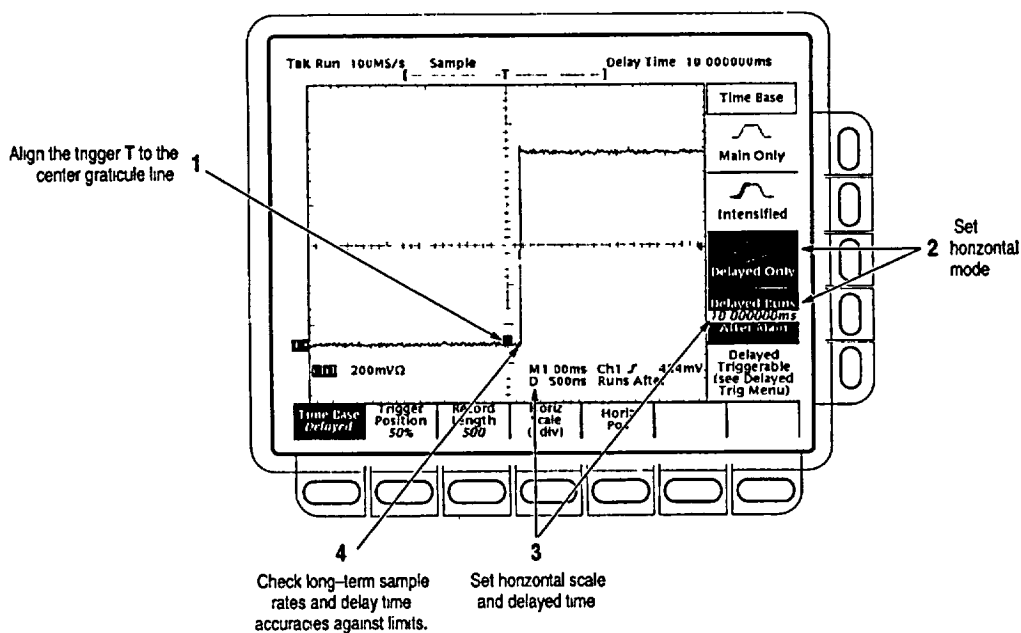

Figure 5. Time Base Accuracy.

- (17) Press front-panel **HORIZONTAL MENU** key.
- (18) Press main-menu **Time Base** key.
- (19) Press side-menu **Delayed Only** key.
- (20) Press side-menu **Delayed Runs After Menu** key.
- (21) Adjust front-panel **HORIZONTAL SCALE** delayed time base (**D**) to 100 ns.
- (22) Set delayed time to 10 ms. Press front-panel **1** and **0** keys.
- (23) Press front-panel **SHIFT** key.
- (24) Press front-panel **m** key.
- (25) Press front-panel **ENTER** key.

(26) If TI rising edge of the marker does not cross the center horizontal graticule line at a point within ± 2.5 divisions of center graticule, perform **b** below.

b. Adjustments. Perform Section IV below.

14. Pulse-Width Triggering

a. Performance Check

- (1) Press front-panel **SETUP** key.
- (2) Press main-menu **Recall Factory Setup** key.
- (3) Press side-menu **OK Confirm Factory Init** key.
- (4) Press front-panel **VERTICAL MENU** key.
- (5) Press main-menu **Coupling** key.
- (6) Press side-menu Ω key to select **50 Ω** setting.
- (7) Adjust front-panel **HORIZONTAL SCALE** knob to display **12.5 ns**.
- (8) Connect leveled sine wave generator leveling head to **CH 1** using X10 attenuator.
- (9) Position leveled sine wave generator controls for a 100 MHz output and five division sine wave.

- (10) Press front-panel **SET LEVEL TO 50%** key.
- (11) Press front-panel **TRIGGER MENU** key.
- (12) Press main-menu **Mode & Holdoff** key.
- (13) Press side-menu **Normal** key.
- (14) Press main-menu **Type** key repeatedly until **Pulse** is highlighted in the menu that pops up.
- (15) Press main-menu **Class** key repeatedly until **Width** is highlighted in the menu that pops up.
- (16) Press main-menu **Trig When** key.
- (17) Press side-menu **Within Limits** key.
- (18) Press side-menu **Upper Limit** key.
- (19) Set upper limit to 10 ns. Press front-panel **1** and **0** keys.
- (20) Press front-panel **SHIFT** key.
- (21) Press front-panel **n** key.
- (22) Press front-panel **ENTER** key.
- (23) Press side-menu **Lower Limit** key.
- (24) Set lower limit to 2 ns. Press front-panel **2** key.
- (25) Press front-panel **SHIFT** key.
- (26) Press front-panel **n** key.
- (27) Press front-panel **ENTER** key.
- (28) Press front-panel **SET LEVEL TO 50%** key.

NOTE

While performing the following, monitor the display (signal stops acquiring) and the front-panel TRIG light to determine when triggering is lost.

- (29) Press side-menu **Lower Limit** key.
- (30) Rotate general purpose knob to *increase* the **Lower Limit** readout until triggering is lost.
- (31) If TI **Lower Limit** readout, after TI loses triggering, does not indicate within 3.5 ns to 6.5 ns, perform **b** below.
- (32) Repeat (23) through (27) above to return lower limits to 2 ns.
- (33) Press side-menu **Upper Limit** key.
- (34) Rotate general purpose knob to *decrease* the **Upper Limit** readout until triggering is lost.
- (35) If **TI Upper Limit** readout, after TI loses triggering, does not indicate within 3.5 ns to 6.5 ns, perform **b** below.
- (36) Press side-menu **Upper Limit** key.
- (37) Set upper limit to 4 μ s. Press front-panel 4 key.
- (38) Press front-panel **SHIFT** key.
- (39) Press front-panel μ key.
- (40) Press front-panel **ENTER** key.
- (41) Press side-menu **Lower Limit** key.
- (42) Set upper limit to 500 ns. Press front-panel **5**, and **0** (twice) keys.
- (43) Press front-panel **SHIFT** key.
- (44) Press front-panel **n** key.
- (45) Press front-panel **ENTER** key.
- (46) Adjust front-panel **HORIZONTAL SCALE** knob to display 5 μ s.
- (47) Position leveled sine wave generator controls for a 250 kHz output, five division sine wave.
- (48) Adjust front-panel **VERTICAL SCALE** knob to display 20 mV.

- (49) Press front-panel **SET LEVEL TO 50%** key.
- (50) Press side-menu **Lower Limit** key.
- (51) Rotate general purpose knob to increase the **Lower Limit** readout until triggering is lost.
- (52) If TI **Lower Limit** readout, after TI loses triggering, does not indicate within 1.9 μs to 2.1 μs , perform **b** below.
- (53) Repeat (41) through (45) above to return lower limits to 500 ns.
- (54) Press side-menu **Upper Limit** key.
- (55) Rotate general purpose knob to decrease the **Upper Limit** readout until triggering is lost.
- (56) If TI **Upper Limit** readout, after TI loses triggering, does not indicate within 1.9 μs to 2.1 μs , perform **b** below.

b. Adjustments. Perform Section IV below.

15. Triggering-Level

a. Performance Check

- (1) Connect equipment as shown in figure 6 below.

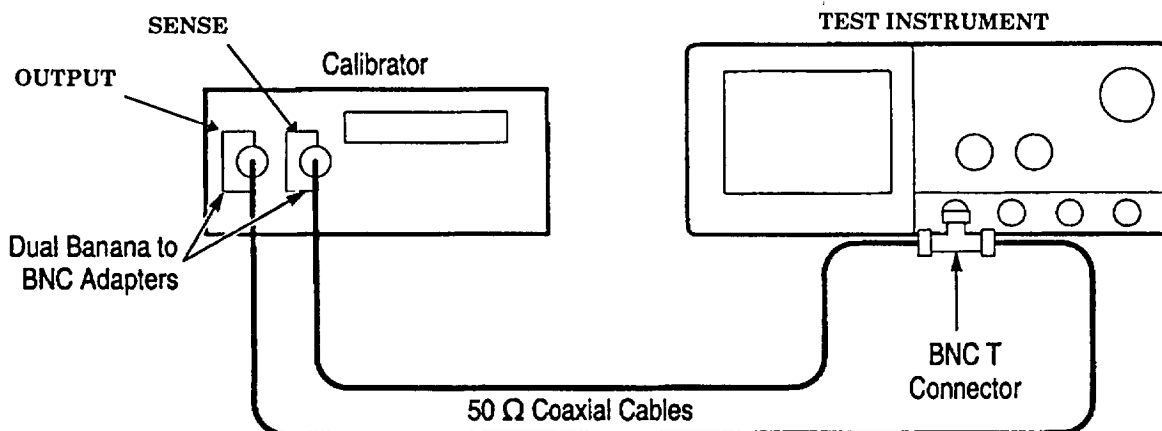



Figure 6. Equipment setup.

- (2) Position calibrator for a 0 V output.
- (3) Press front-panel **SETUP** key.

- (4) Press main-menu **Recall Factory Setup** key.
- (5) Press side-menu **OK Confirm Factory Init** key.
- (6) Adjust front-panel **VERTICAL SCALE** knob to display 200 mV.
- (7) Press front-panel **VERTICAL MENU** key.
- (8) Press main-menu **Position** key.
- (9) Set vertical position to **-3** divisions. Press front-panel **-** and **3** keys.
- (10) Press front-panel **ENTER** key.
- (11) Press main-menu **Offset** key.
- (12) Set vertical offset to **+10** volts. Press front-panel **1** and **0** keys.
- (13) Press front-panel **ENTER** key.
- (14) Position calibrator for a +10 V output.
- (15) Press front-panel **SET LEVEL TO 50%** key.
- (16) Press front-panel **TRIGGER MENU** key.
- (17) If TI main-menu **Level** readout does not indicate between 9.9393 and 10.1147 V, perform **b** below.
- (18) Press main-menu **Slope** key.
- (19) Press side-menu negative slope  key.
- (20) Repeat (14) and (15) above.
- (21) If TI **Level** readout does not indicate between 9.9393 and 10.1147 V, perform **b** below.
- (22) Press main-menu **HORIZONTAL MENU** key.
- (23) Press main-menu **Time Base** key.
- (24) Press side-menu **Delayed Only** key.
- (25) Press side-menu **Delayed Triggerable** key.

- (26) Adjust front-panel **HORIZONTAL SCALE** knob to display a delay (D) time base of 500 μ s.
- (27) Press front-panel **SHIFT** key.
- (28) Press front-panel **DELAYED TRIG** key.
- (29) Press main-menu **Level** key.

NOTE

Notice in the following step the *side-menu* SET TO 50% key is called for, not the *front-panel* SET LEVEL TO 50% key.

- (30) Press side-menu **SET TO 50%** key.
- (31) If TI main-menu **Level** readout does not indicate between 9.9393 and 10.1147 V, perform **b** below.
- (32) Press main-menu **Slope** key.
- (33) Press side-menu negative slope  key.
- (34) Press main-menu **Level** key.

NOTE

Notice in the following step the *side-menu* SET TO 50% key is called for, not the *front-panel* SET LEVEL TO 50% key.

- (35) Press side-menu **SET TO 50%** key.
- (36) If TI main-menu **Level** readout does not indicate between 9.9393 and 10.1147 V, perform **b** below.

b. Adjustments. Perform Section IV below.

16. Sensitivity and Edge Trigger

a. Performance Check

- (1) Press front-panel **SETUP** key.
- (2) Press main-menu **Recall Factory Setup** key.
- (3) Press side-menu **OK Confirm Factory Init** key.

- (4) Adjust front-panel **HORIZONTAL SCALE** knob to display a main (**M**) time base of 25 ns.
- (5) Press front-panel **HORIZONTAL MENU** key.
- (6) Press main-menu **Time Base** key.
- (7) Press side-menu **Delayed Only** key.
- (8) Press side-menu **Delayed Triggerable** key.
- (9) Adjust front-panel **HORIZONTAL SCALE** knob to display a delayed (**D**) time base of 25 ns.
- (10) Press side-menu **Main Only** key.
- (11) Press front-panel **TRIGGER MENU** key.
- (12) Press main-menu **Mode & Holdoff** key.
- (13) Press side-menu **Normal** key.
- (14) Press front-panel **VERTICAL MENU** key.
- (15) Press main-menu **Coupling** key.
- (16) Press side-menu Ω key to select **50 Ω** setting.
- (17) Press front-panel **Shift** key.
- (18) Press front-panel **ACQUIRE MENU** key.
- (19) Press main-menu **Mode** key.
- (20) Press side-menu **Average 16** key.
- (21) Connect equipment as shown in figure 7 below.

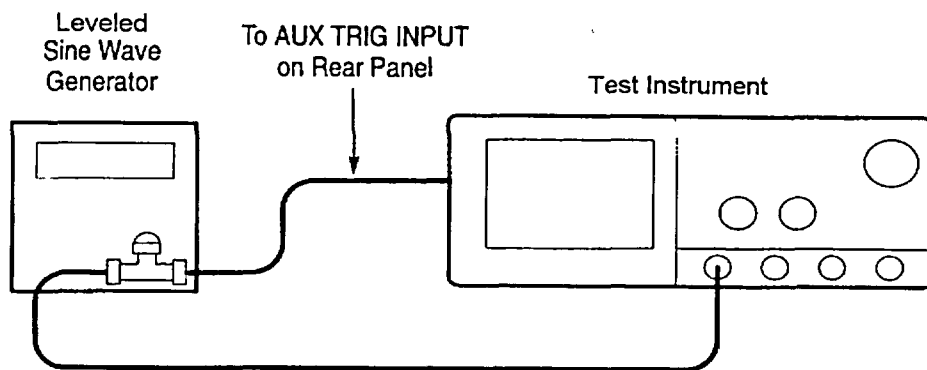

Figure 7. Equipment setup.

- (22) Position leveled sine wave generator controls for a 50 MHz, 350 mV output.
- (23) Press front-panel **Measure** key.
- (24) Press main-menu **High-Low Setup** key.
- (25) Press side-menu **Min-Max** key.
- (26) Press main-menu **Select Measrmt for Ch 1** key.
- (27) Press side-menu **-more-** key until **Amplitude** appears in the side-menu.
- (28) Press side-menu **Amplitude** key.
- (29) Press front-panel **SET LEVEL TO 50%** key.
- (30) Press front-panel **CLEAR MENU** key.
- (31) Position leveled sine wave generator controls for an amplitude of 3.5 divisions.
- (32) Position leveled sine wave generator controls for a 350 mV **C1 Ampl** readout.
- (33) Disconnect cable from **CH 1** and reconnect it to **CH 1** through X10 attenuator

NOTE



A stable trigger is one that is consistent; that is, one that results in a uniform, regular display triggered on the selected slope (positive or negative). This display should not have its trigger point switching between opposite slopes, nor should it roll across the screen. At horizontal scale settings of 2 ms/division and faster, TRIG'D will remain constantly lighted. It will flash for slower settings.

(34) Press front-panel **TRIGGER MENU** key.

(35) Press main-menu **Slope** key.

(36) Press front-panel **SET LEVEL TO 50%** key.

(37) Adjust front-panel **TRIGGER MAIN LEVEL** knob until **TRIG'D** light is on. Set level to near the middle of range where the **TRIG'D** light is on.

(38) If TI waveform trigger is not stable for both the positive and negative slopes, perform **b** below. Press side-menu  and  keys to switch between trigger slopes.

(39) Press side-menu  key.

(40) Press front-panel **HORIZONTAL MENU** key.

(41) Press main-menu **Time Base** key.

(42) Press side-menu **Delayed Only** key.

(43) Press side-menu **Delayed Triggerable** key.

(44) Press front-panel **Shift** key.

(45) Press front-panel **DELAYED TRIG** key.



(46) Press main-menu **Level** key.



NOTE

Notice in the following step the side-menu SET TO 50% key is called for, not the front-panel SET LEVEL TO 50% key.



(47) Press side-menu **SET TO 50%** key.

(48) Press main-menu **Slope** key.

(49) If TI waveform trigger is not stable for both the positive and negative slopes, perform **b** below. Press side-menu  and  keys to switch between trigger slopes. Adjust front-panel **TRIGGER MAIN LEVEL** knob to stabilize main trigger, and front-panel general purpose knob to stabilize delayed trigger if required.

(50) If TI waveform trigger is not stable for both the positive and negative slopes, perform **b** below. Press side-menu  and  keys to switch between trigger slopes.

(51) Press side-menu  key.

- (52) Press front-panel **HORIZONTAL MENU** key.
- (53) Press main-menu **Time Base** key.
- (54) Press side-menu **Main Only** key.
- (55) Press front-panel **CLEAR MENU** key.
- (56) Remove X10 attenuator and reconnect to **CH 1**.
- (57) Position leveled sine wave generator controls for an amplitude of 2.5 divisions.
- (58) Position leveled sine wave generator controls for a 250 mV **C1 Ampl** readout. Readout may fluctuate.
- (59) Press front-panel **TRIGGER MENU** key.
- (60) Press main-menu **Source** key.
- (61) Press side-menu **-more-** key until **DC Aux** appears in the side-menu.
- (62) Press side-menu **DC Aux** key.
- (63) Press front-panel **SET LEVEL TO 50%** key.
- (64) Press main-menu **Slope** key.
- (65) If T1 waveform trigger is not stable for both the positive and negative slopes, perform **b** below. Press side-menu  and  keys to switch between trigger slopes. Adjust front-panel **TRIGGER LEVEL** knob to stabilize trigger if required.
- (66) Press side-menu  key.
- (67) Press main-menu **Source** key.
- (68) Press side-menu **-more-** key until **CH 1** appears in the side-menu.
- (69) Press side-menu **Ch 1** key.
- (70) Remove equipment setup and connect leveled sine wave generator leveling head to **CH 1**.
- (71) Adjust front-panel **HORIZONTAL SCALE** knob to display a main (**M**) time base of 500 ps.

- (72) Press front-panel **HORIZONTAL MENU** key.
- (73) Press main-menu **Time Base** key.
- (74) Press side-menu **Delayed Only** key.
- (75) Press side-menu **Delayed Triggerable** key.
- (76) Adjust front-panel **HORIZONTAL SCALE** knob to display a delayed (**D**) time base of 500 ps.
- (77) Press side-menu **Main Only** key.
- (78) Position leveled sine wave generator controls for a 500 MHz output, five division sine wave.
- (79) Position leveled sine wave generator controls for a 500 mV **C1 Ampl** readout. Readout may fluctuate. Press front-panel **SET LEVEL TO 50%** key to stabilize readout if required.
- (80) Disconnect leveling head from **CH 1** and reconnect it to **CH 1** through an X5 attenuator.
- (81) Repeat technique of (34) through (50) above.

b. Adjustments. Perform Section IV below.

17. Trigger Output Signal

a. Performance Check

- (1) Connect oscilloscope calibration workstation calibration generator **OUTPUT** to **CH 3**.
- (2) Position calibration generator controls for 0.500 V, 100Hz output.
- (3) Connect rear-panel **Main Trigger Out** to **CH 2**.
- (4) Press front-panel **SETUP** key.
- (5) Press main-menu **Recall Factory Setup** key.
- (6) Press side-menu **OK Confirm Factory Init** key.
- (7) Adjust front-panel **HORIZONTAL SCALE** knob to display 200 ps.

- (8) Press front-panel **SHIFT** key.
- (9) Adjust front-panel **ACQUIRE MENU** key.
- (10) Press main-menu **Mode** key.
- (11) Press side-menu **Average** key.
- (12) Adjust front-panel general purpose knob to set averages to **64**.
- (13) Press front-panel **WAVEFORM OFF** key.
- (14) Press front-panel **CH 2** key.
- (15) Adjust front-panel **VERTICAL SCALE** knob to display 1 V.
- (16) Adjust front-panel **VERTICAL POSITION** knob to center test signal.
- (17) Press front-panel **MEASURE** key.
- (18) Press main-menu **Select Measrmt for Ch2** key.
- (19) Repeatedly press side-menu **-more-**key until **High** and **Low** appear in side-menu.
- (20) Press side-menu **High** and **Low** keys.
- (21) If TI **C2 High** readout does not indicate ≥ 2.5 V and **C2 Low** does not indicate ≤ 0.7 V, perform **b** below.
- (22) Press front-panel **VERTICAL MENU** key.
- (23) Press main-menu **Coupling** key.
- (24) Press side-menu **W** key to select **50 W** setting.
- (25) If TI **C2 High** readout does not indicate ≥ 1.0 V and **C2 Low** does not indicate ≤ 0.25 V, perform **b** below.
- (26) Remove connection from rear-panel **Main Trigger Output** and connect rear-panel **Delayed Trigger Output** to **CH 2**.
- (27) If TI **C2 High** readout does not indicate ≥ 1.0 V and **C2 Low** does not indicate ≤ 0.25 V, perform **b** below.
- (28) Press side-menu Ω key to select **1 MW** setting.

2.

- (29) Press front-panel **CLEAR MENU** key.
- (30) If TI **C2 High** readout does not indicate ≥ 2.5 V and **C2 Low** does not indicate ≤ 0.7 V, perform **b** below.
- (31) Remove connection from rear-panel **Delayed Trigger Output** and connect rear-panel **SIGNAL OUT** to **CH**
- (32) Press front-panel **TRIGGER MENU** key.
- (33) Press main-menu **Source** key.
- (34) Press side-menu **Ch3** key.
- (35) Adjust front-panel **VERTICAL SCALE** knob to display **100 mV**.
- (36) Press front-panel **SET LEVEL TO 50%** key.
- (37) Press front-panel **MEASURE** key.
- (38) Press main-menu **Select Measrmt for Ch2** key.
- (39) Repeatedly press side-menu **-more-**key until **Pk-Pk** appears in side-menu.
- (40) Press side-menu **Pk-Pk** key.
- (41) Press front-panel **CLEAR MENU** key.
- (42) If TI **Ch2 Pk-Pk** readout does not indicate between 88 mV and 132 mV, perform **b** below.
- (43) Press front-panel **VERTICAL MENU** key.
- (44) Press main-menu **Coupling** key.
- (45) Press side-menu **W** key to select **50 W** setting.
- (46) Press front-panel **CLEAR MENU** key.
- (47) If TI **Ch2 Pk-Pk** readout does not indicate between 44 mV and 66 mV, perform **b** below.

b. Adjustments. Perform Section IV below.

18. Probe Compensator Output

a. Performance Check

- (1) Connect equipment as shown in figure 8 below.

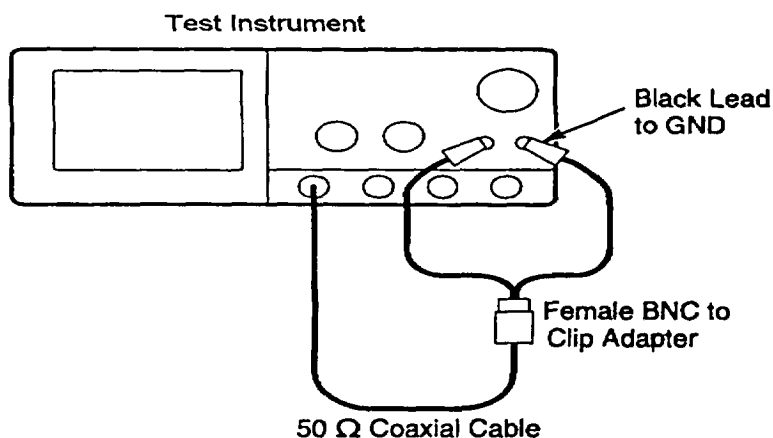

Figure 8. Equipment setup.

- (2) Press front-panel **SETUP** key.
- (3) Press main-menu **Recall Factory Setup** key.
- (4) Press side-menu **OK Confirm Factory Init** key.
- (5) Adjust front-panel **HORIZONTAL SCALE** knob to display **200 ms**.
- (6) Press front-panel **SET LEVEL TO 50%** key.
- (7) Adjust front-panel **VERTICAL POSITION** knob to center test signal.
- (8) Press front-panel **SHIFT** key.
- (9) Press front-panel **ACQUIRE MENU** key.
- (10) Press main-menu **Mode** key.
- (11) Press side-menu **Average** key.
- (12) Adjust general purpose knob to set averages to **128**.
- (13) Press front-panel **MEASURE** key.

- (14) Press main-menu **Select Measrmt for Ch 1** key.
- (15) Repeatedly press side-menu **-more-**key until **Frequency** appears in side-menu.
- (16) Press side-menu **Frequency** key.
- (17) If TI **Ch 1 Freq** readout does not indicate between 950 Hz and 1.050 kHz, perform **b** below.
- (18) Press front-panel **MEASURE** key.
- (19) Press main-menu **Remove Measrmt** key.
- (20) Press side-menu **Measurement 1** key.
- (21) Press front-panel **WAVEFORM** key.
- (22) Press main-menu **Save Wfm Ch 1** key.
- (23) Press side-menu **To Ref 1** key to save probe compensation signal reference.
- (24) Remove equipment setup.
- (25) Press front-panel **MORE** key.
- (26) Press main-menu **Ref 1** key.
- (27) Press **CH 1** key.
- (28) Connect equipment as shown in figure 9 below.

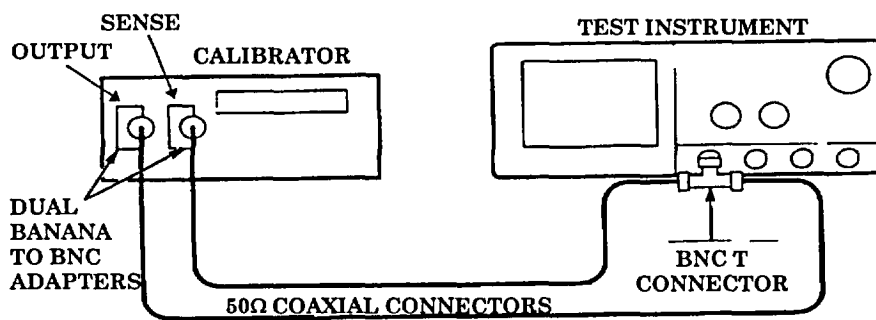

Figure 9. Equipment setup.

- (29) Position calibrator for a 0 V output.
- (30) Press front-panel **Shift** key.
- (31) Press front-panel **ACQUIRE MENU** key.
- (32) Press main-menu **Mode** key.
- (33) Press side-menu **Average** key.
- (34) Adjust general purpose knob to set averages to **16**.

(35) Position calibration generator controls until signal precisely overlaps top (upper) level of stored compensation signal. Value will be near 0.5 V. Record value.

(36) If TI **Ch2 High** readout does not indicate between ≥ 1.0 V and **Ch2 Low** does not indicate between ≤ 0.25 V, perform **b** below.

(37) Position calibration generator controls until signal precisely overlaps base (lower) level of stored compensation signal. Value will be near 0 V. Record value.

- (38) Press front-panel **CLEAR MENU** key.

(39) Subtract the lower level value from the top level value. If value does not indicate between 495 and 505 mV, perform **b** below.

19. Final Procedure

- a. Deenergize and disconnect all equipment.
- b. Annotate and affix DA label/form in accordance with TB 750- 25.

SECTION IV ADJUSTMENT PROCESS

20. Preliminary Instructions. The procedure in paragraphs **21** through **22** should be performed only if an out-of-tolerance condition exists in paragraphs **8** through **19** above.

21. Equipment Setup

WARNING

HIGH VOLTAGE is used or exposed during the performance of this calibration. DEATH ON CONTACT may result if personnel fail to observe safety precautions. REDUCE OUTPUT(S) to minimum after each step within the performance check where applicable.

- a. Connect TI to a 115V ac source.

NOTE

When **ON/STBY** button is pressed, the TI automatically performs a self-test sequence. Upon successful completion of self-test, TI will be in normal operating mode.

- b. Press **ON/STBY** button and allow at least 20 minutes for equipment warm-up.

22. Adjustment Process**NOTE**

Steps a through g are instructions required to initially install the TDS 500B and 700A Field Adjustment Software and will not need to be performed again unless the software is corrupted. If software is already installed, proceed to note prior to step g and continue adjustment process.

- a. Install a working copy disk of the TDS 500B and 700A Field Adjustment Software in the electronic technical bulletin (ETB) process controller (PC) floppy disk drive and type *install* at the floppy disk drive prompt.
- b. The installation program will prompt you to specify information. Respond as follows:
 - (1) Hard Drive: Enter C or drive of your choice.
 - (2) Computer Type: Enter **2**.
 - (3) GBIP Board Type: Enter **1**.
 - (4) DMA Channel: Enter **0**.
 - (5) Interrupt: Enter **0**.
 - (6) Switch Setting: Enter **68**.
- c. The installation program will create a directory on the hard drive called TDS700.ADJ.

- d. When "Installation Complete" appears, remove installation disk and store in a secure place.

NOTE

Use a editor of your choice to make the following changes to the ADJ700.BAT file located in the TDS700.ADJ directory.

- e. Change directories to the TDS700.adj directory and edit the following lines in the ADJ700.BAT file:

(1) Change **SET GBIP0=PC2 0 0 68** to **SET GBIP0=.** (Delete PC2 0 0 68)

(2) Change **SET GBIP1=** to **SET GBIP1=PC2 0 0 68.** (Add PC2 0 0 68)

- f. Save modified ADJ700.BAT file and reset the controller.

NOTE

If the TDS 500B/700A Field Adjustment Software is already installed on the PC, go to the TDS700.ADJ drive and directory where the software is located.

- g. At the TDS700.ADJ directory prompt, type *ADJ700* to initiate the adjustment process.

CAUTION

The following adjustment process must be completed in it's entirety before deenergizing TI. If the adjustment process cannot be completed, keep TI energized until adjustment process can be completed.

- h. Enter **7** to select the TDS540B.
- i. Enter **1** to select RUN FULL SEQUENCE.

NOTE

Refer to the following diagram for the MEMORY WRITE PROTECT SWITCH referenced in the adjustment process.

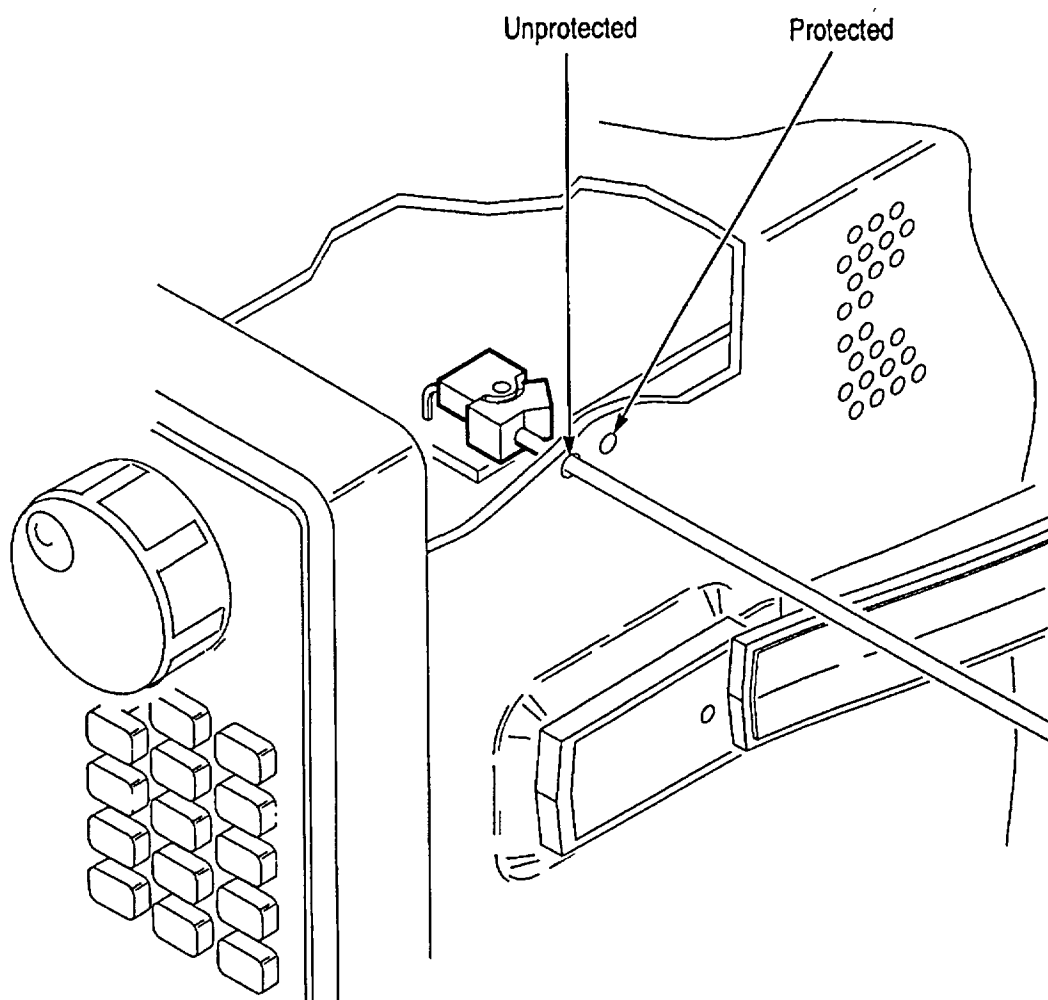

Figure 10. Memory write protection switch location.

NOTE

Substitute the 5700A calibrator for the DP8200 calibrator. Substitute the oscilloscope calibration generator for the SG504 and SG503. Substitute the 8840/AF for the DMM.

CAUTION

When prompted to choose a channel to adjust, select "ALL" each time. When prompted to choose "Do Section" or "Skip Section", select "Do Section" every time.

NOTE

In the TRIGPOSCAL adjustment, the 22 MHz, 7 division amplitude check, if the signal is not triggered, the TRIGGER MAIN LEVEL key may need to be adjusted to trigger signal.

- (1) Follow instructions to complete the adjustment process.

NOTE

If the 700A Field Adjustment Software produces a failing error, it is recommended that the adjustment process continue until the failing section can be re-run. If software is interrupted or stopped, the adjustment process will have to be initiated again from the beginning.

- j. Repeat/perform paragraphs 8 through 19 above.

By Order of the Secretary of the Army:

Official:

DENNIS J. REIMER
General, United States Army
Chief of Staff

JOEL B. HUDSON
Administrative Assistant to the
Secretary of the Army
04316

Distribution:

To be distributed in accordance with initial distribution number (IDN) 344629 requirements for calibration procedure TB 9-6625-2320-35.

